

“The convenient truth:  
cities and sustainability”

CNU XVI

April 5, 2008

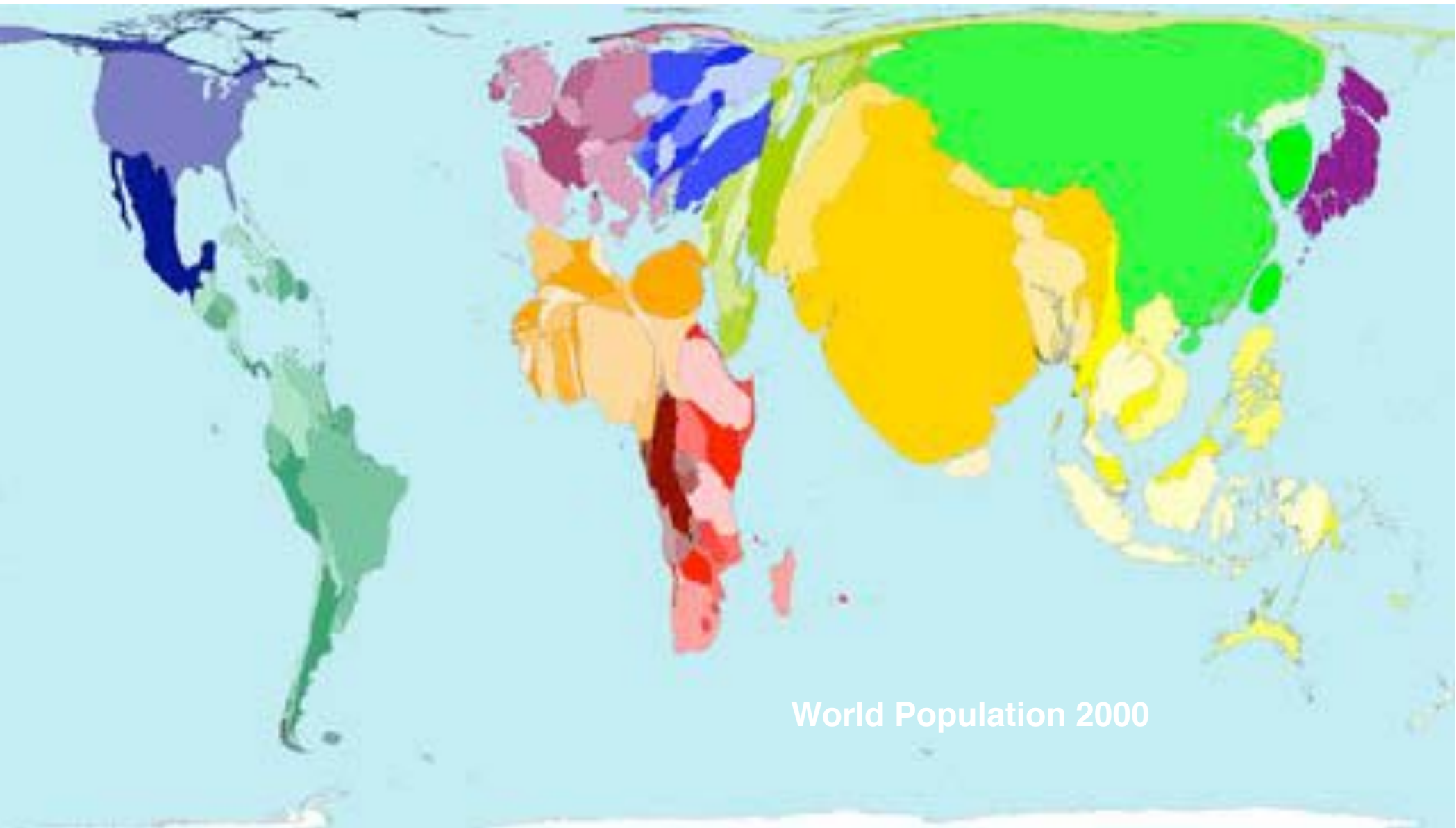

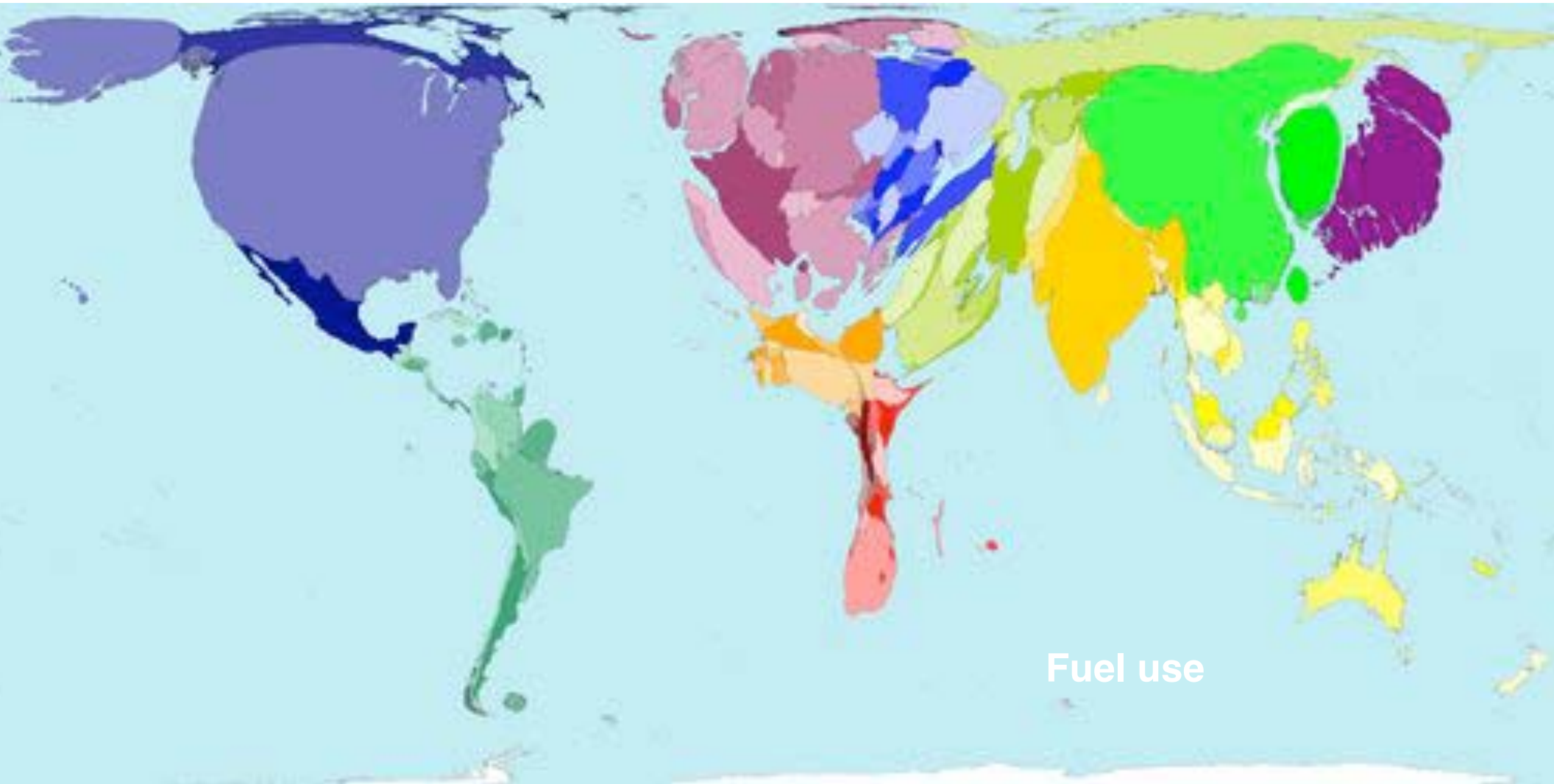

Fuel use

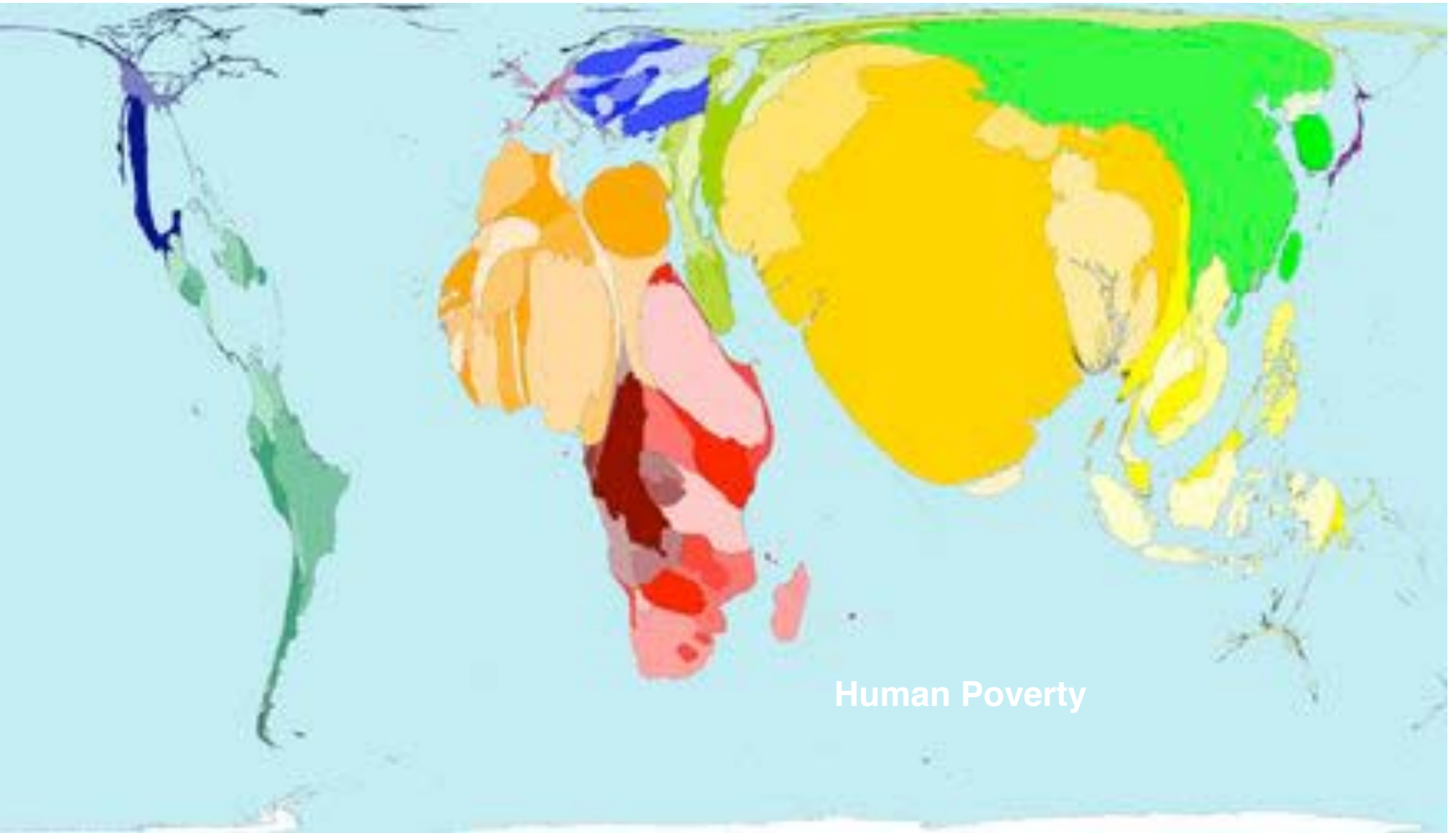

Human Poverty

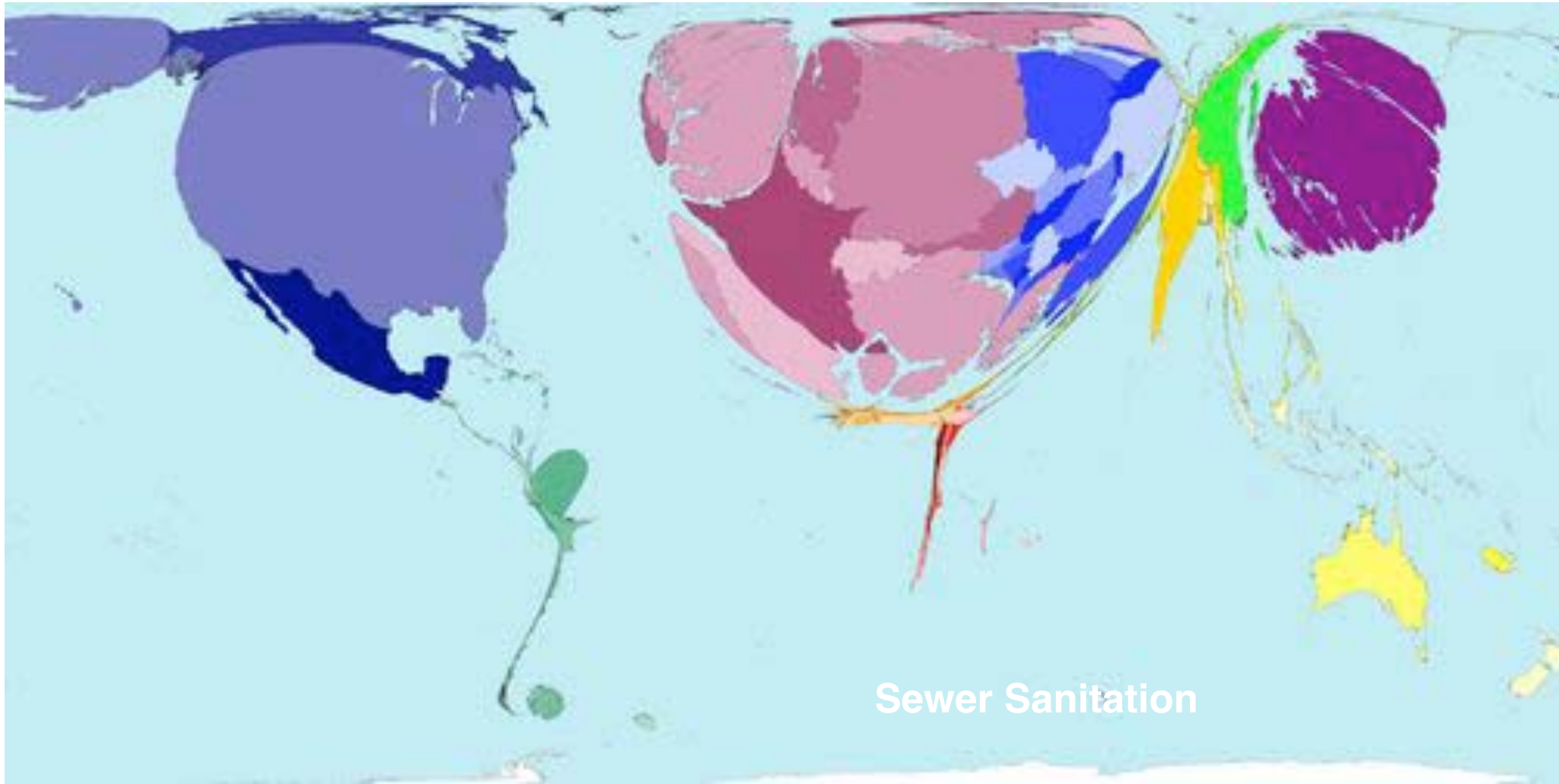

Sewer Sanitation

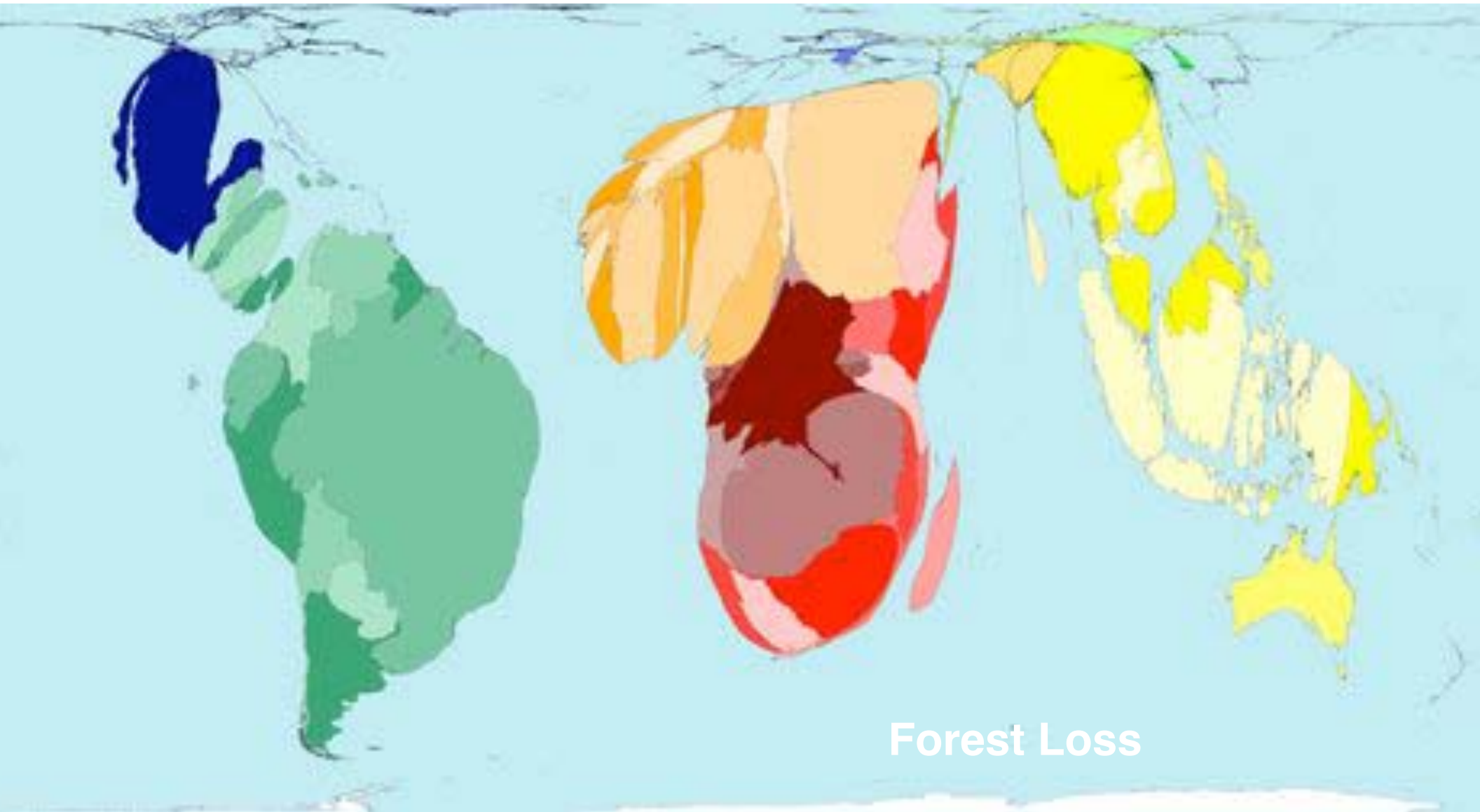

Forest Loss



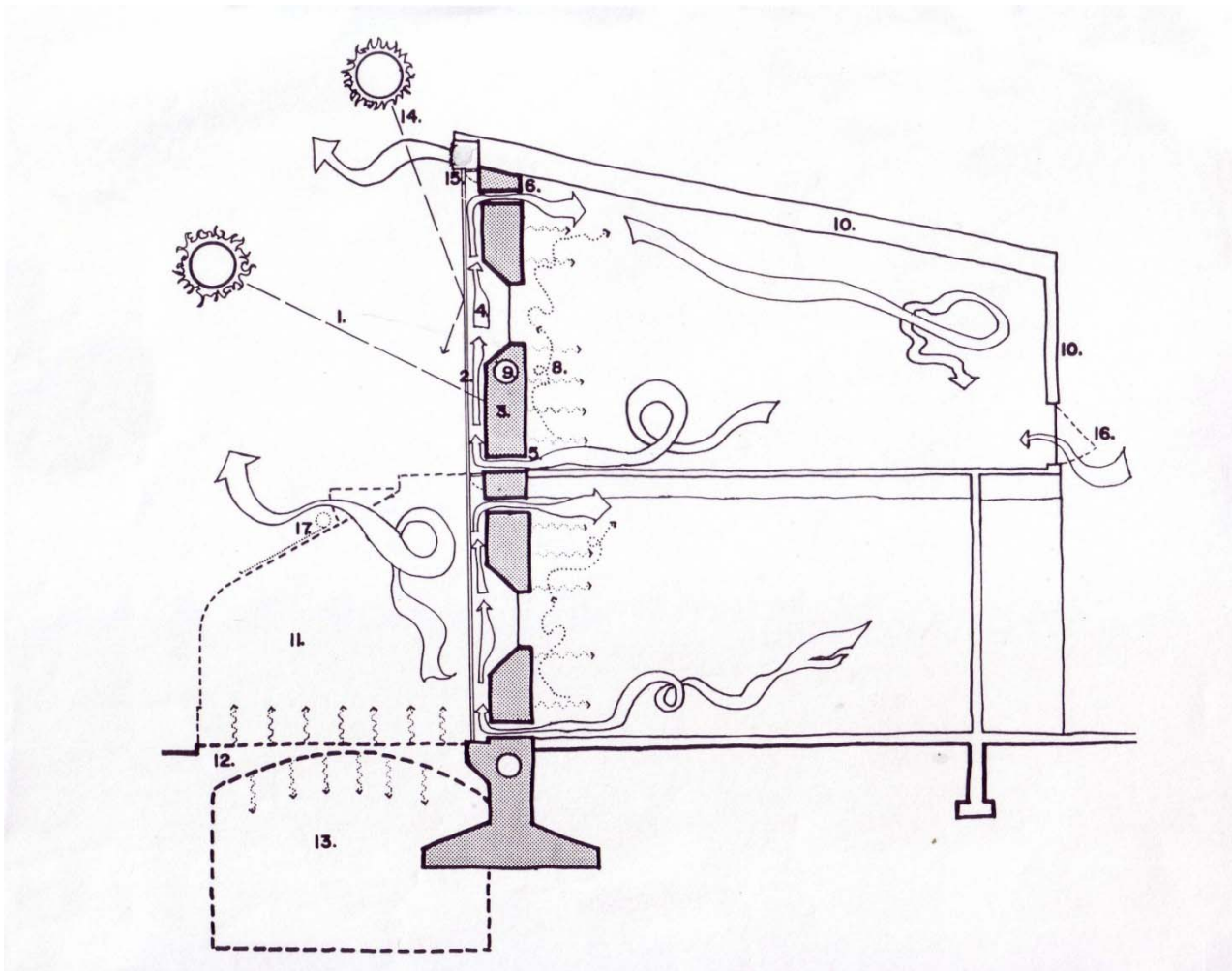

PC

Mac





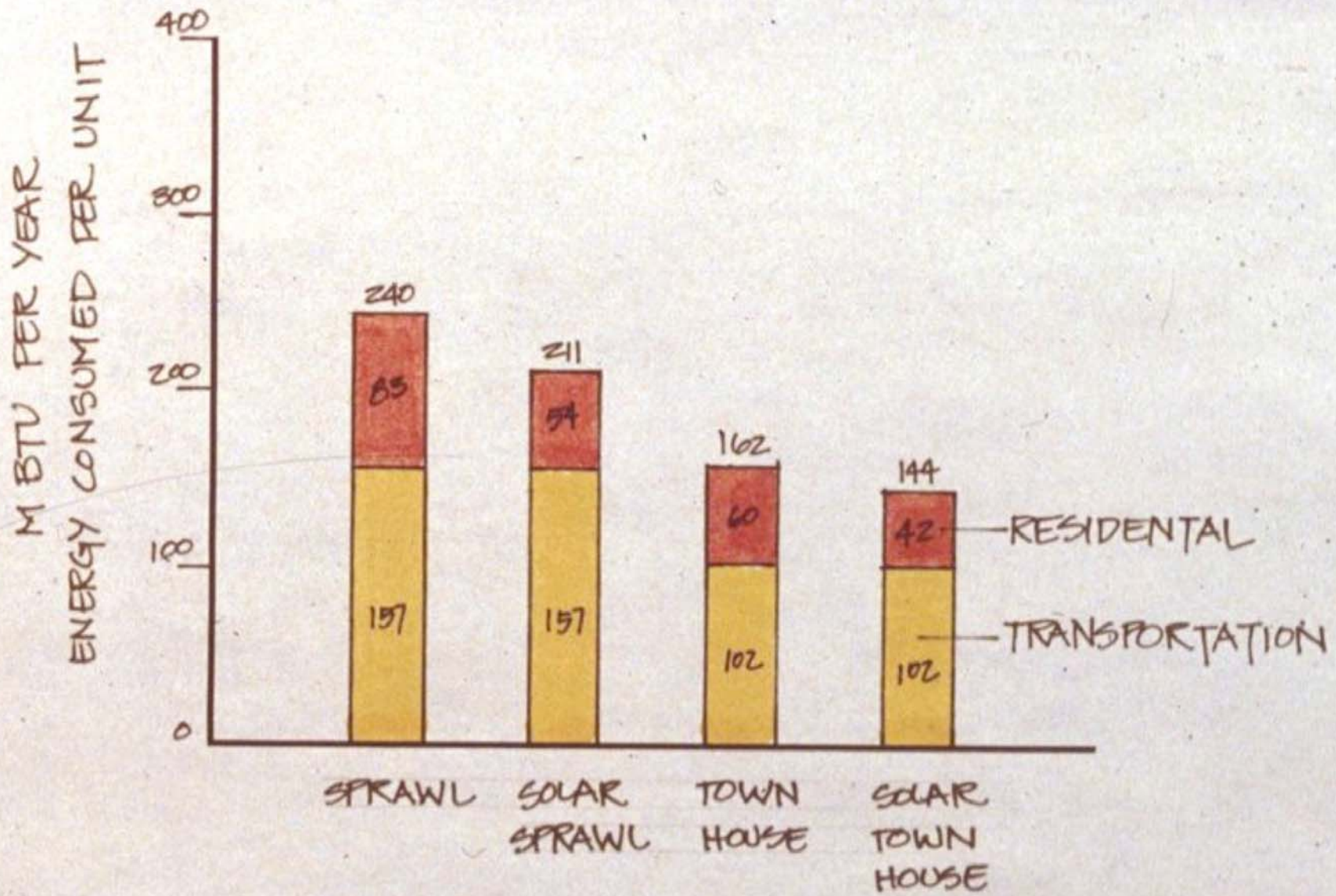

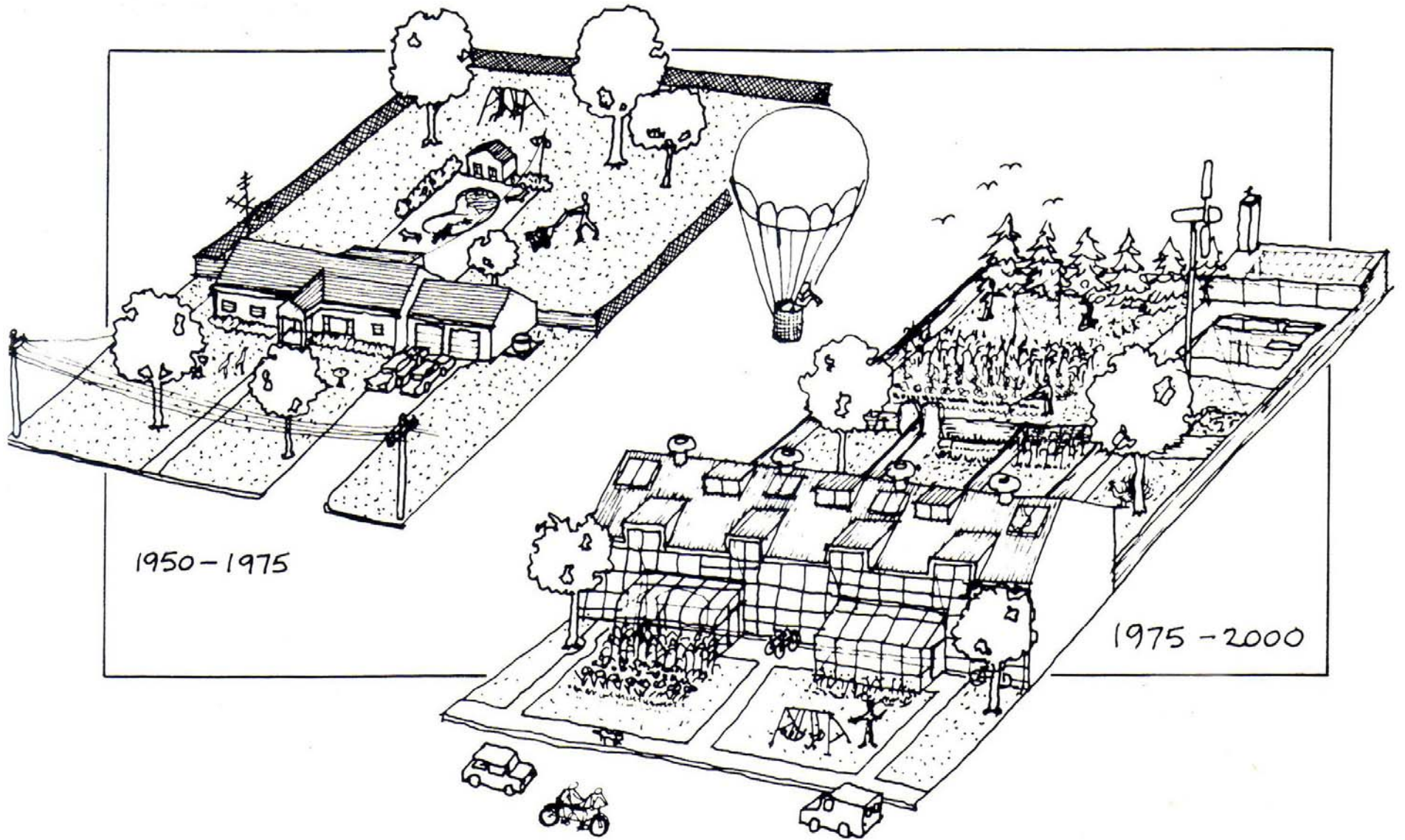

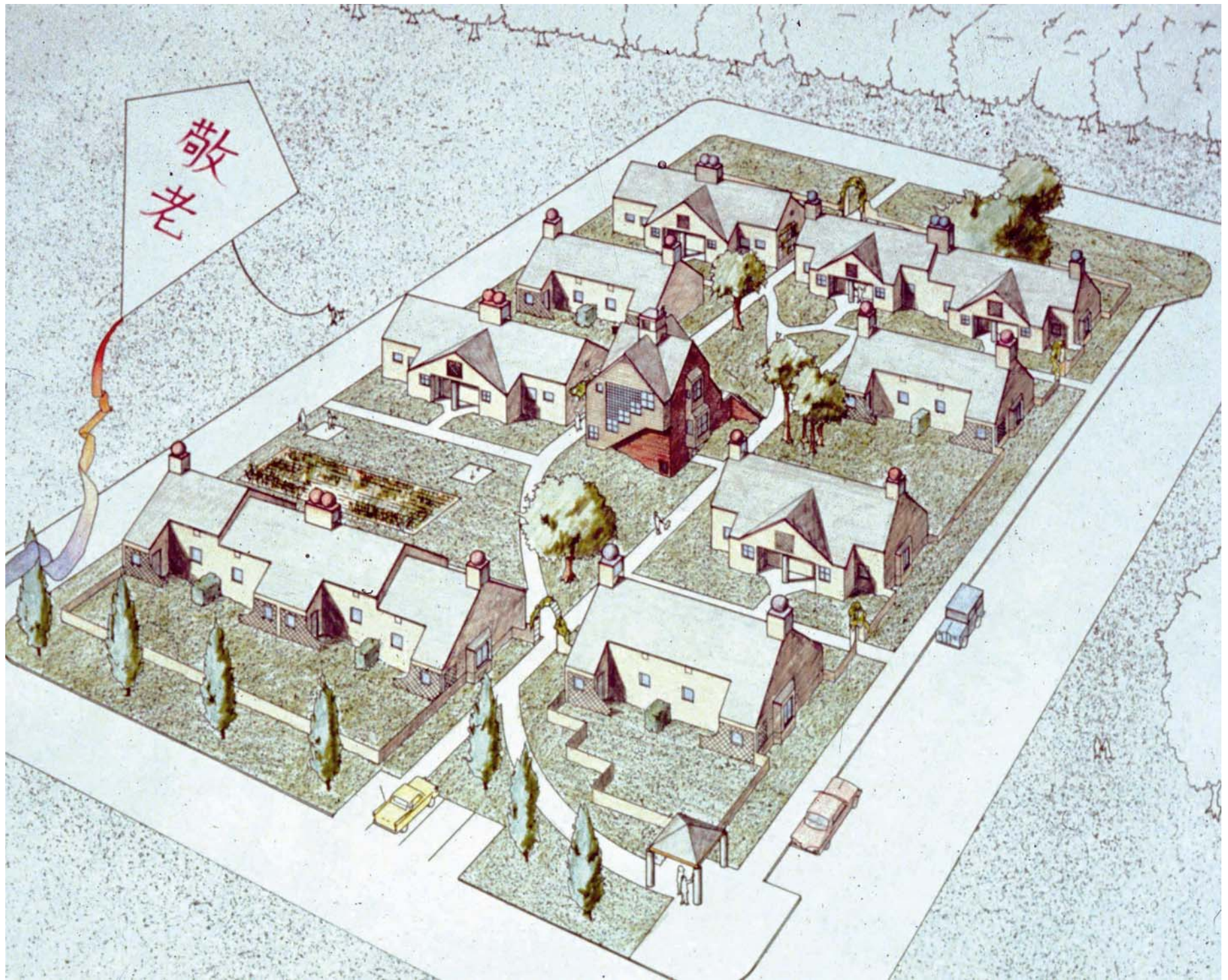

敬老





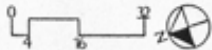
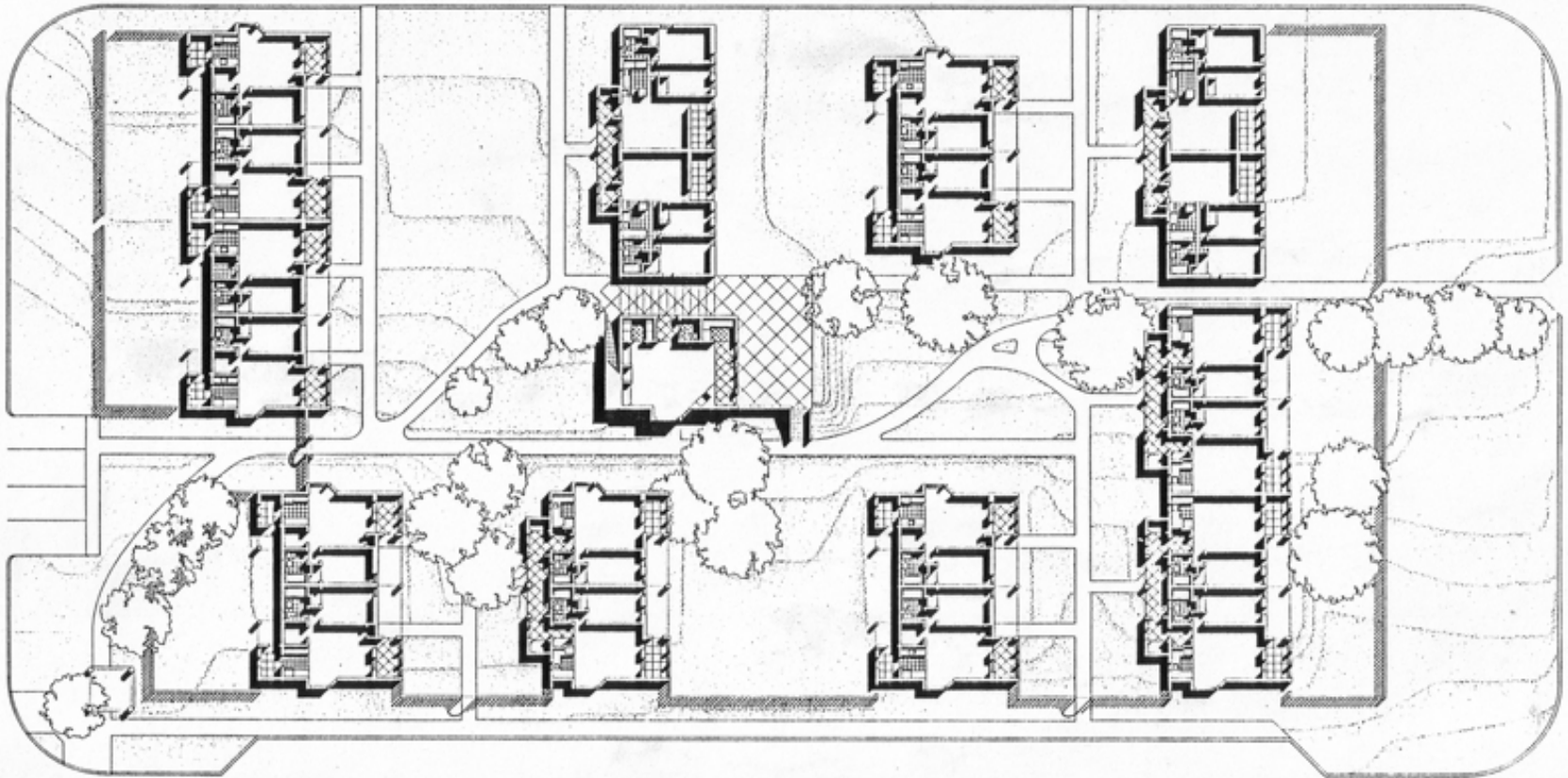

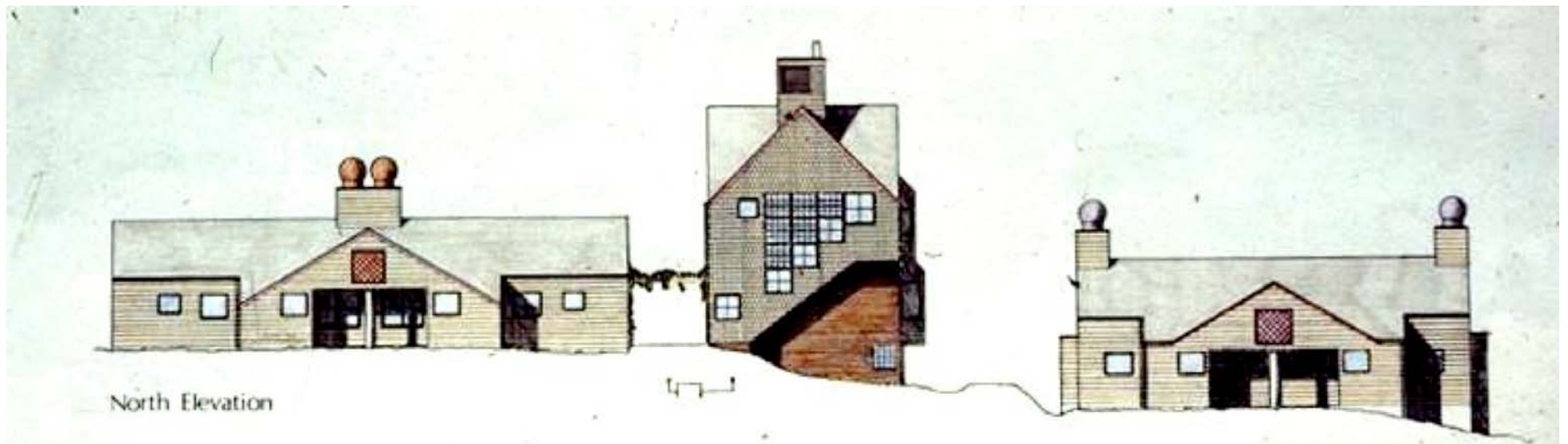

North Elevation

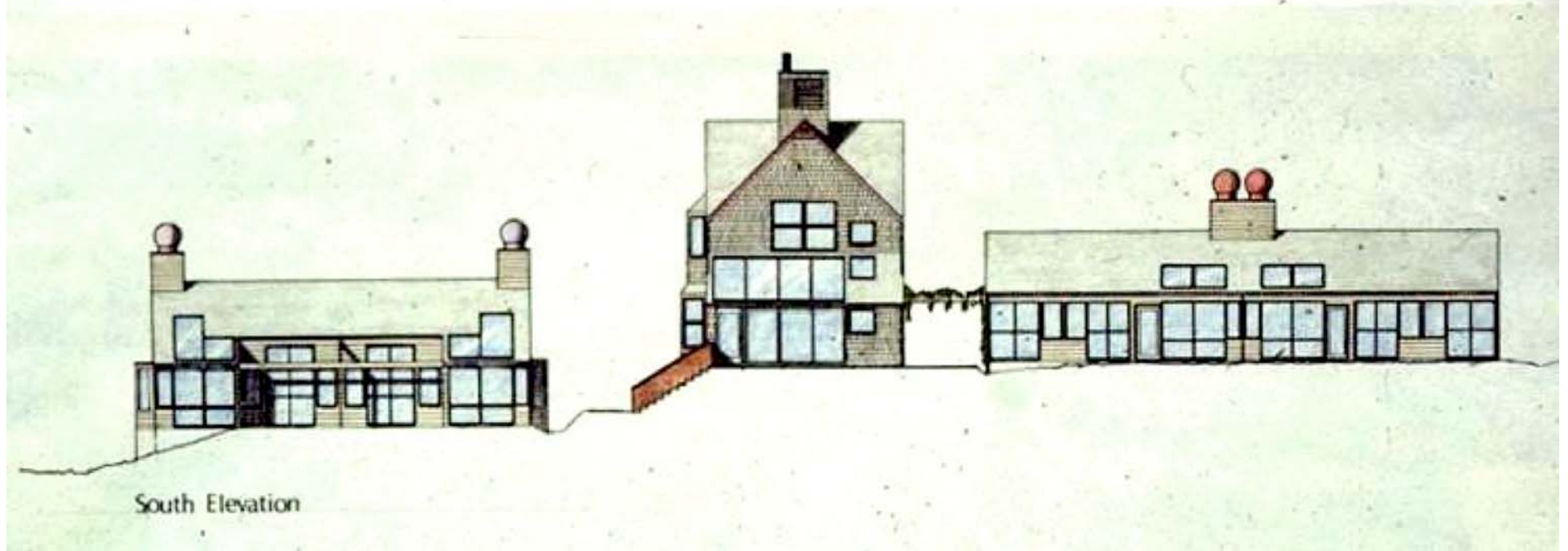

South Elevation



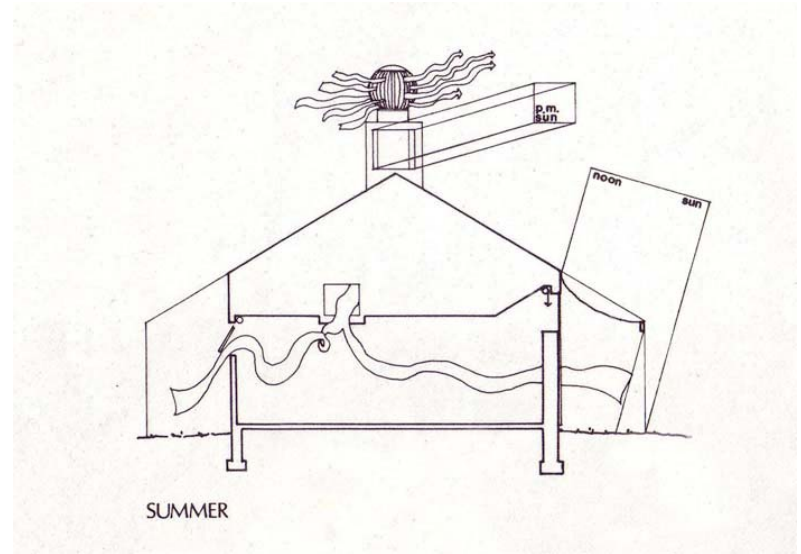
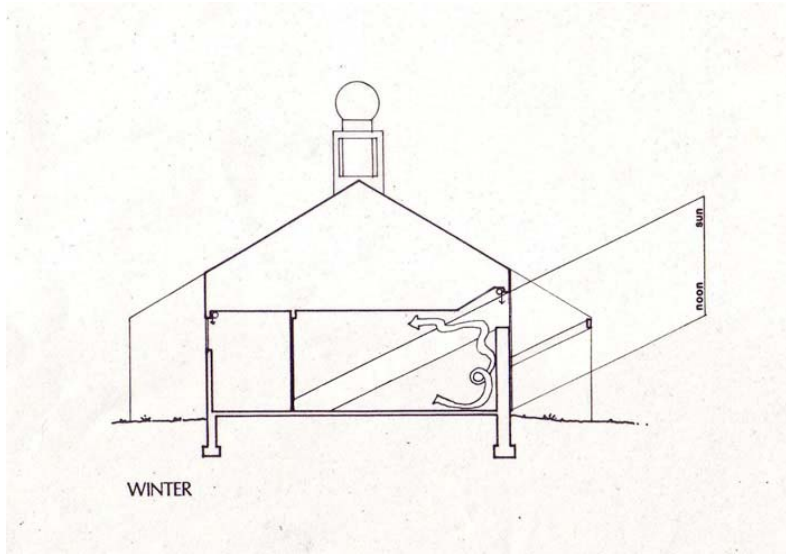

PC

Mac

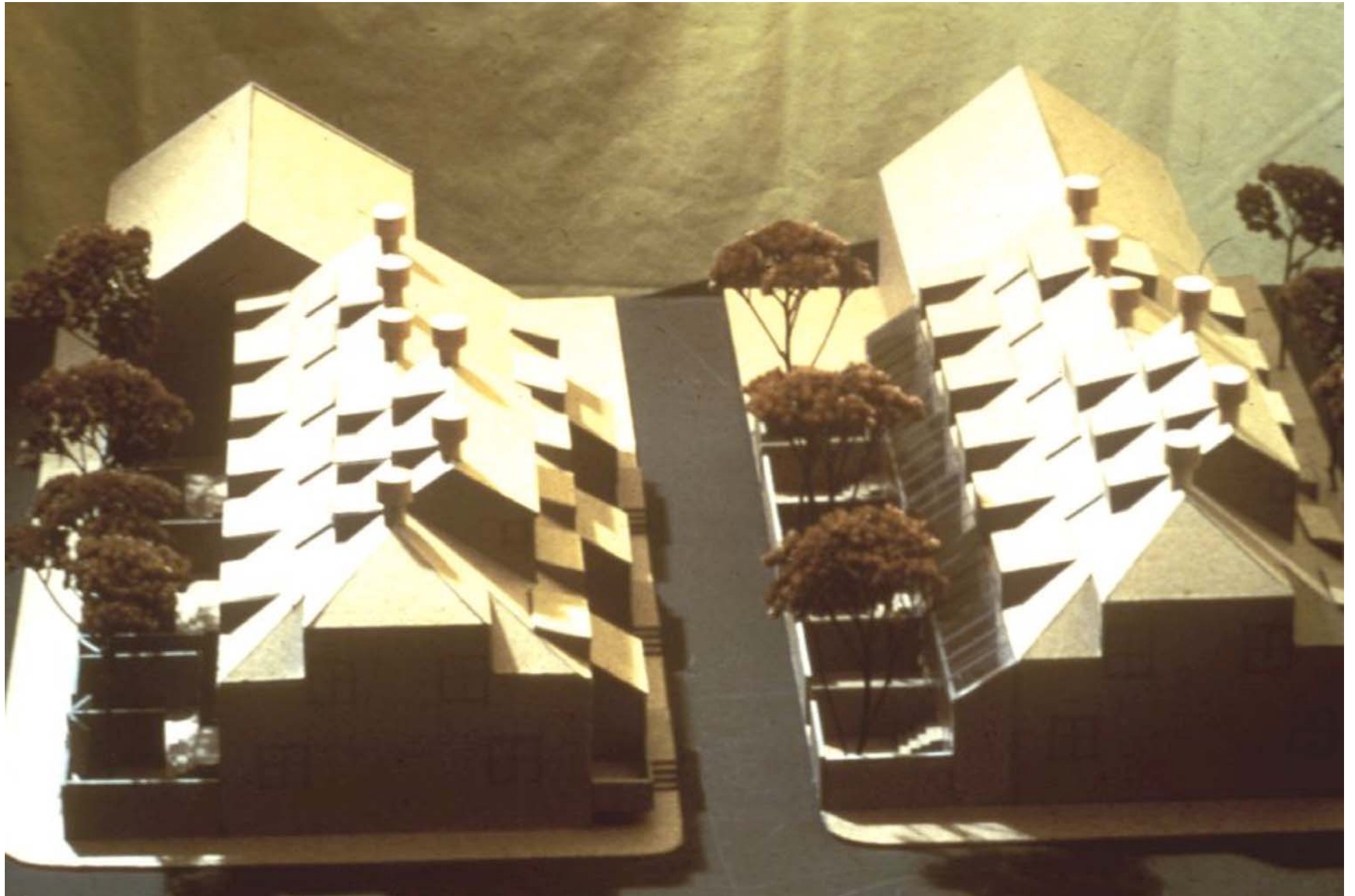

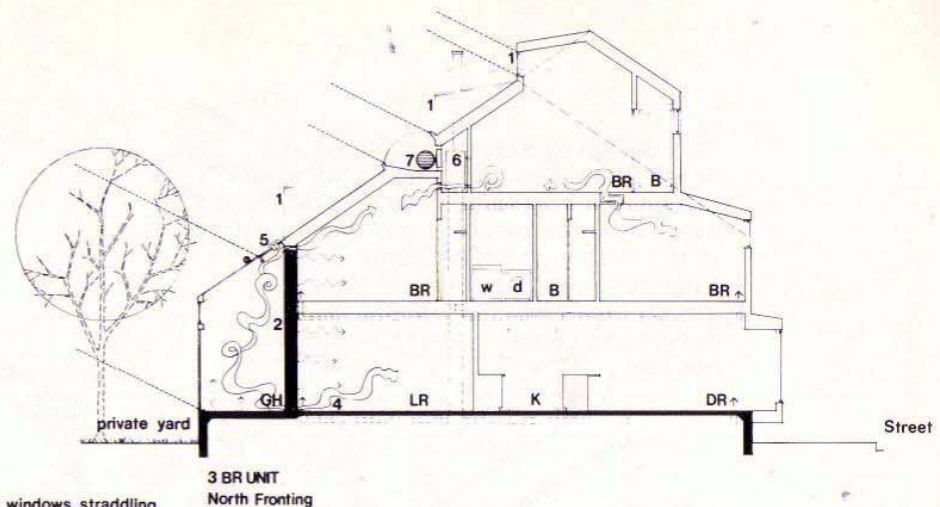
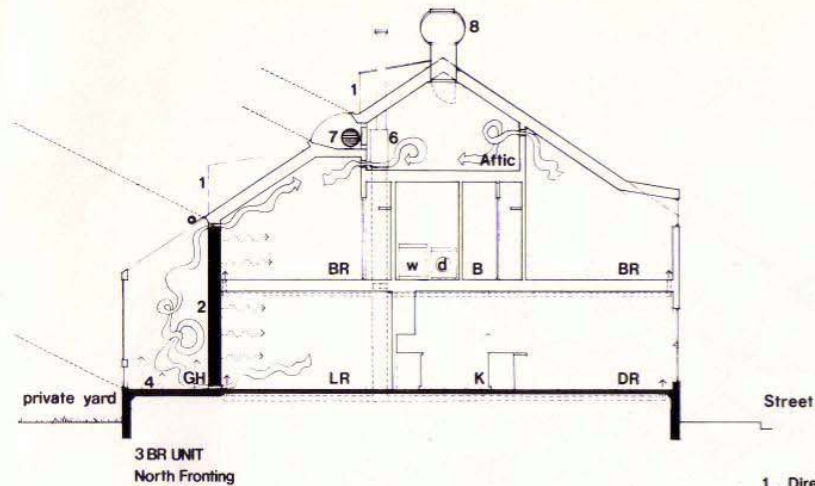

1. Direct Gain dormer windows straddling masonry party wall as thermal storage
2. 12 inch masonry wall covered with selective surface foil for thermal storage
3. 12 inch stagnating Trombe Wall covered with selective surface foil
4. 8 inch dark concrete slab as thermal storage
5. summer exhaust fan
6. gas furnace
7. domestic hot water preheater
8. rotary ventilator

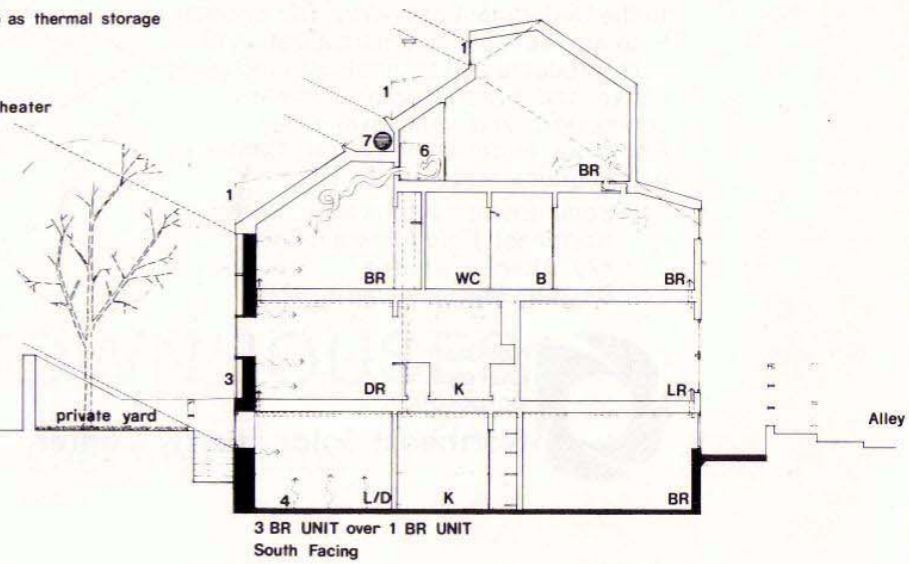
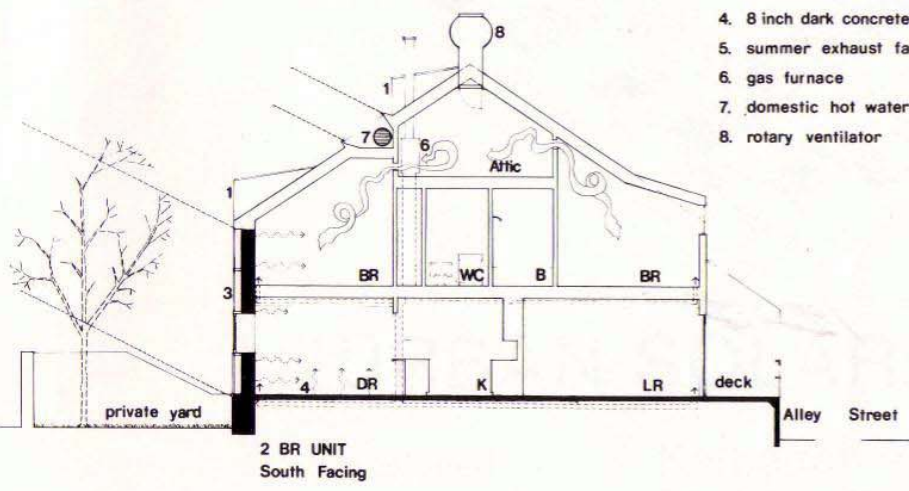

**Sections**

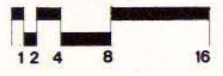



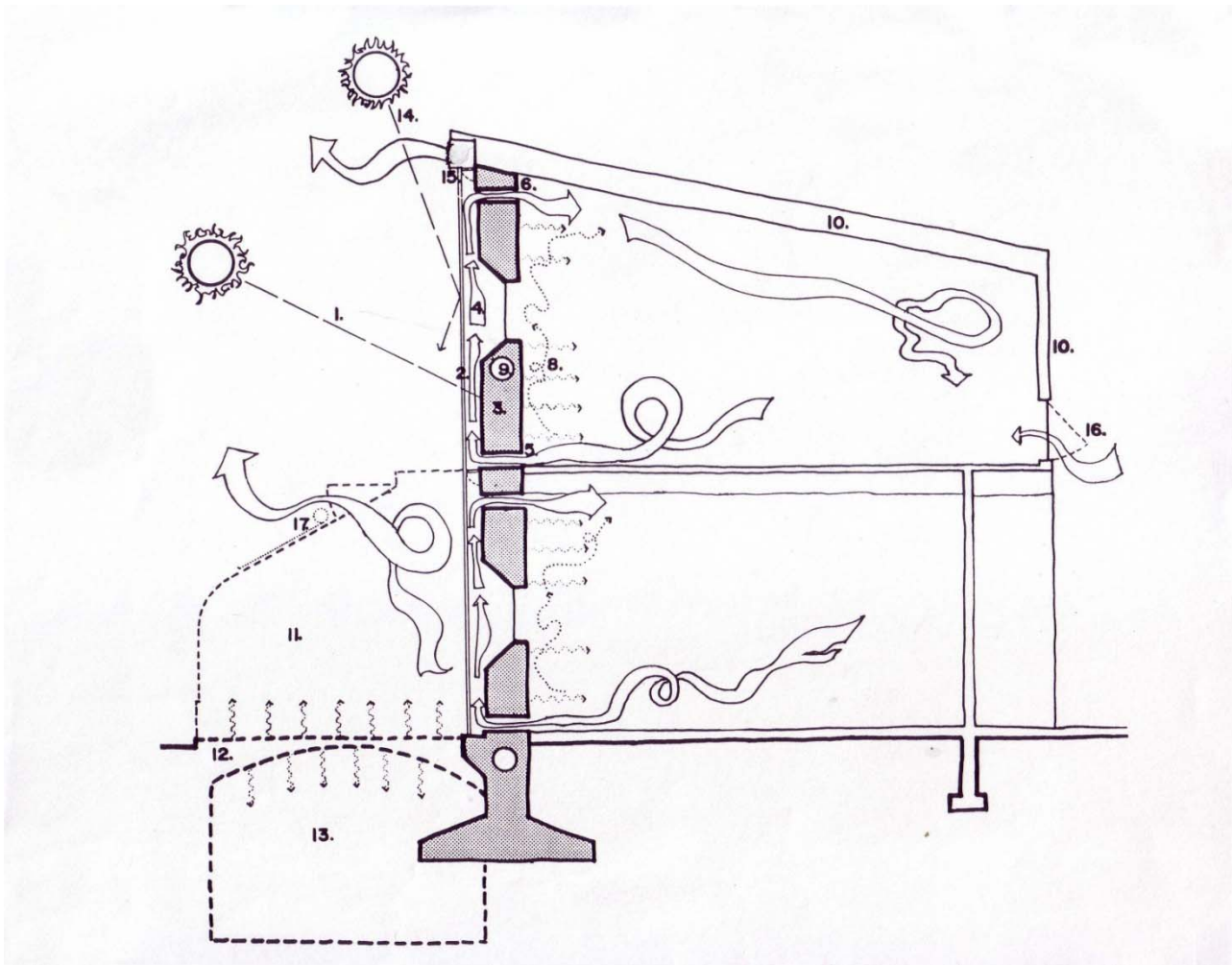

PC

Mac

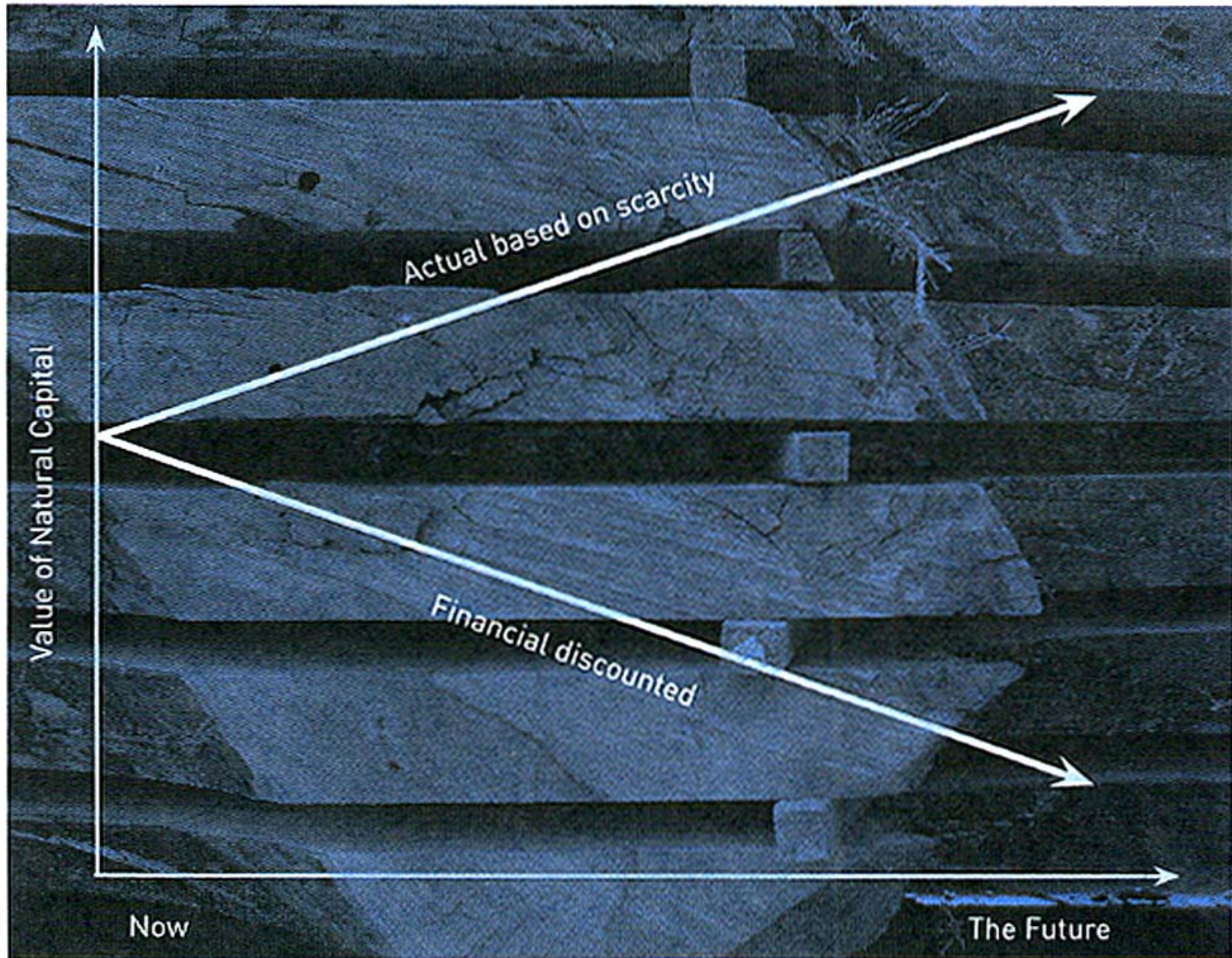

Discounting the future.

